

PK 76002 EH

**FUNCTIONAL DESIGN. FOR
SERVICE FRIENDLINESS,
BEST APPEARANCE AND
HIGH VALUE RETENTION.**

LIFETIME EXCELLENCE

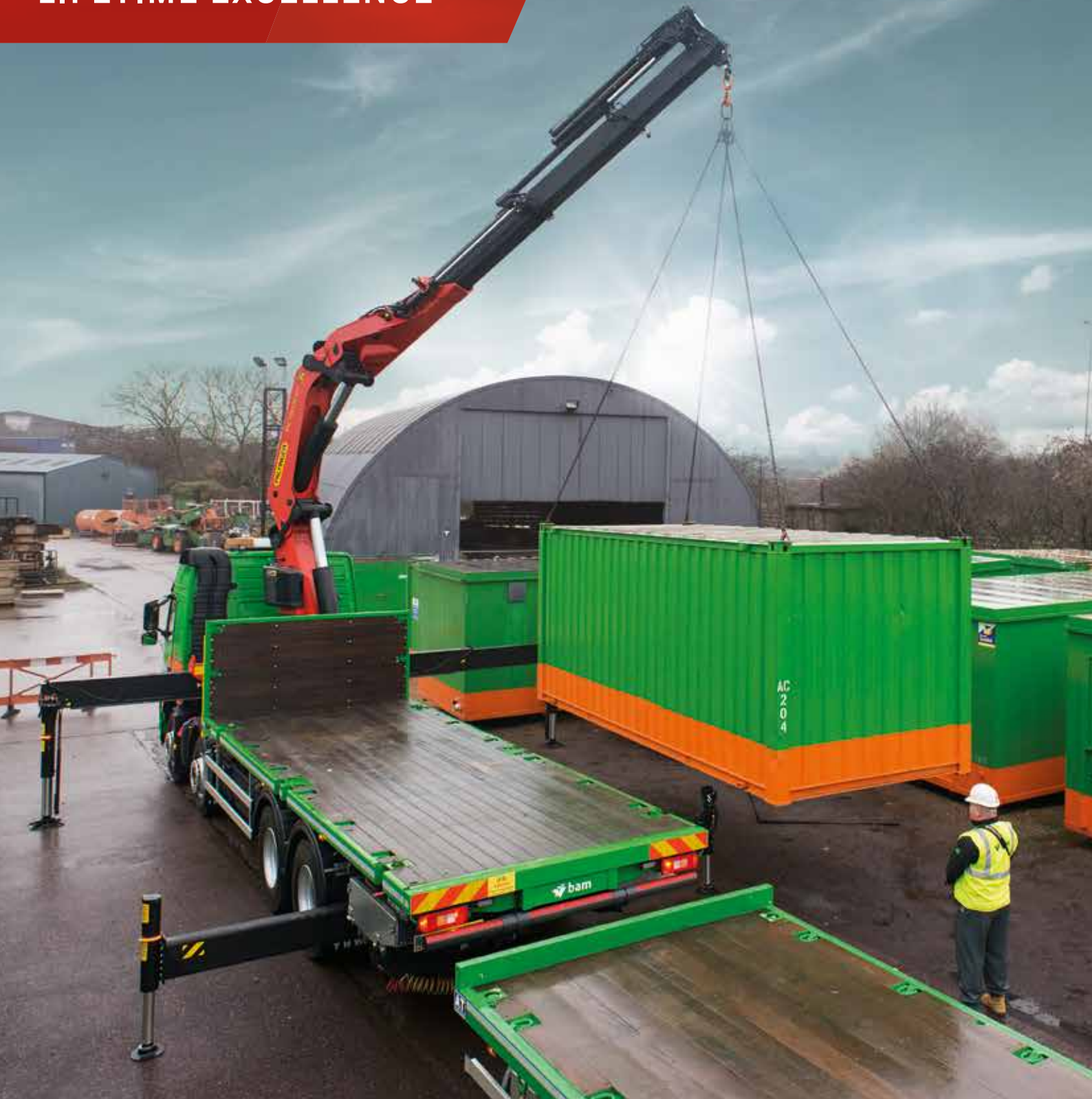

OPERATOR-FRIENDLY PRODUCT DESIGN

- Additional applications due to Power Link Plus
- Maximum utilisation of the working range due to HPSC
- Practical and attractive due to Functional Design
- More lifting power due to E-HPLS





FIRST-RATE IN DESIGN AND PERFORMANCE



Coating technology

Top quality surface protection at a glance

The KTL coating lays the foundation for a perfect surface protection. Afterwards the components are either coated in the powder-coating facility or are finished with a two-components-topcoat. High value retention and excellent corrosion protection for the whole life of a crane.



Power Link Plus

High variety of uses

With the 15-degree reverse linkage system, you can reach through low door openings and also work inside buildings. Heavy crane work – even in difficult conditions.



Low-maintenance extension system

Reduces service time

With sliding elements made of synthetic material and the high-quality KTL coating, this boom system significantly simplifies service performed by the operator. This saves time and money – and protects the environment.

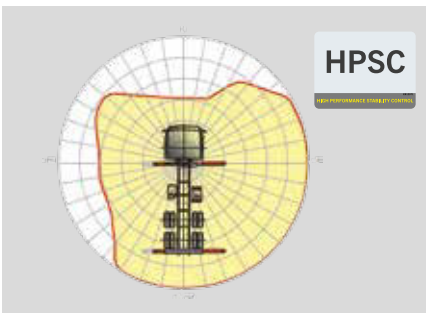

HPSC

Maximum utilisation of the working range

The variable stabiliser positioning of the High Performance Stability Control System makes it possible to utilise the lifting capacity to the maximum. It enables working within tight spaces.



High Speed Extension

For efficient assignments

The High Speed Extension speeds up the extension boom system. Crane works faster and more efficiently.



Radio remote control

Dialogue with the operator

PALFINGER radio remote controls are equipped with linear lever or cross lever and provide the greatest possible comfort for the operator. All EH models with LED-Display inform the crane operator about the different operating conditions.



Power Link cable winch

More comfort in cable winch operation

Characterised by low installation height, it is ideal for working inside buildings and transports with the crane boom unfolded. The Comfort Cable Routing reduces set-up times to a minimum.



Functional design

Practical and attractive

Robust plastic covers protect crane parts against dirt and damage. Better appearance and increased operational comfort – during the entire lifetime.



Continuous slewing system

Unrestricted movement

More efficient in operation due to faster loading cycles, since the crane can be slewed over a shorter distance. The crane works more efficiently and faster.

PERFECT DIMENSIONS

Technical specifications EN 12999 HC1 HD4/B3

Max. lifting moment	71,6 mt/702,4 kNm	518020 ft.lbs	Stabiliser spread (std.)	8,6 m	28' 3"
Max. lifting capacity	23000 kg/225,6 kN	50710 lbs	Fitting space required (std.)	min. 1,56 m	5' 1"
Max. hydraulic outreach	20,4 m	66' 11"		max. 1,71 m	5' 7"
Max. manual outreach	25,1 m	82' 4"	Width folded	2,55 m	8' 4"
Max. outreach (with fly-jib)	30,5 m	100' 1"	Max. operating pressure	350 bar	5075 psi
Slewing angle	endless		Recommended pump capacity	from 80 l/min	21,1 US gal./min
Slewing torque 1 gear	4,5 mt/44,1 kNm	32560 ft.lbs		to 100 l/min	26,4 US gal./min
Slewing torque 2 gears	7,0 mt/68,7 kNm	50640 ft.lbs	Dead weight (std.)	5910 kg	13030 lbs

DIMENSIONS

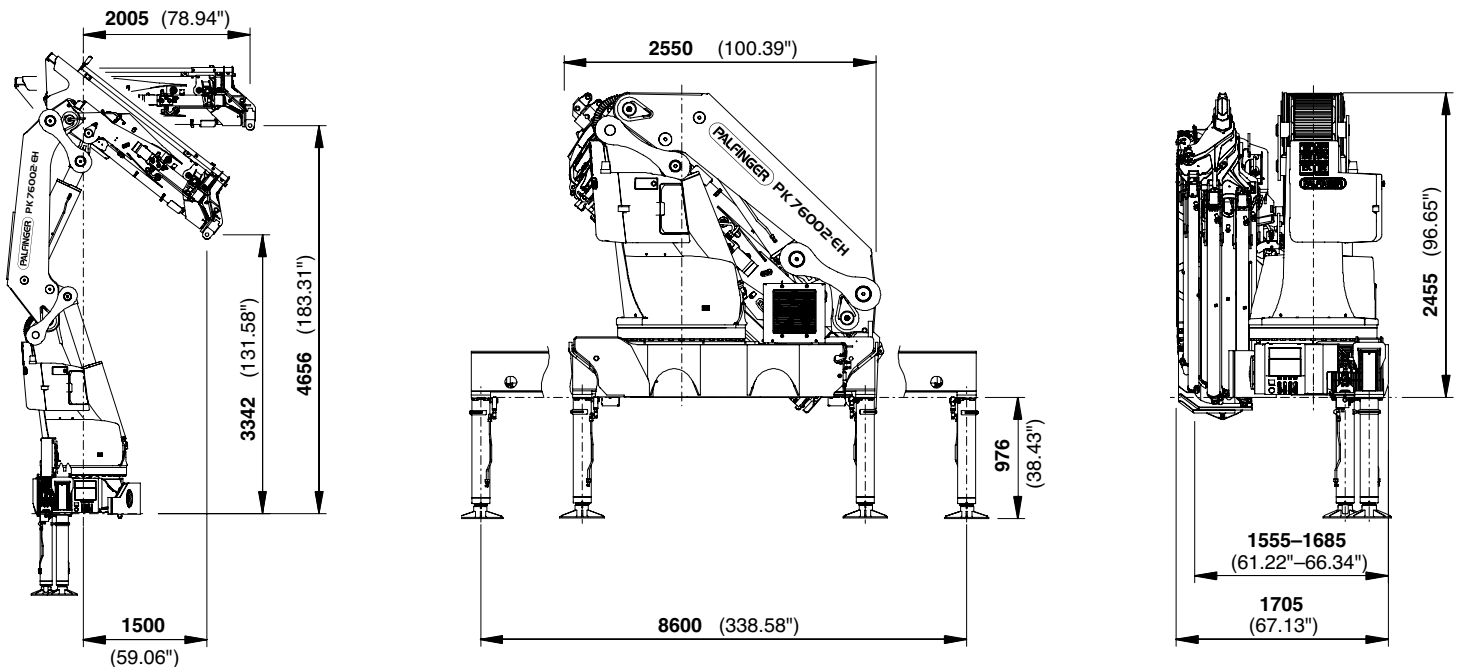

PK 76002 EH

HIGH PERFORMANCE

Perfect for high outreaches.

D

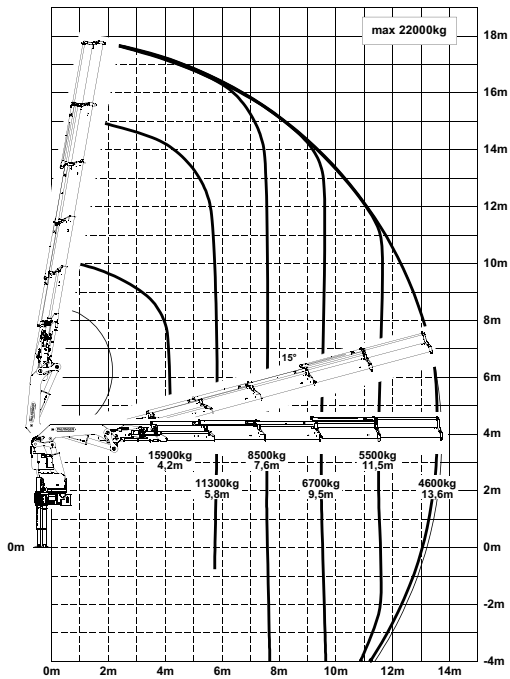

E

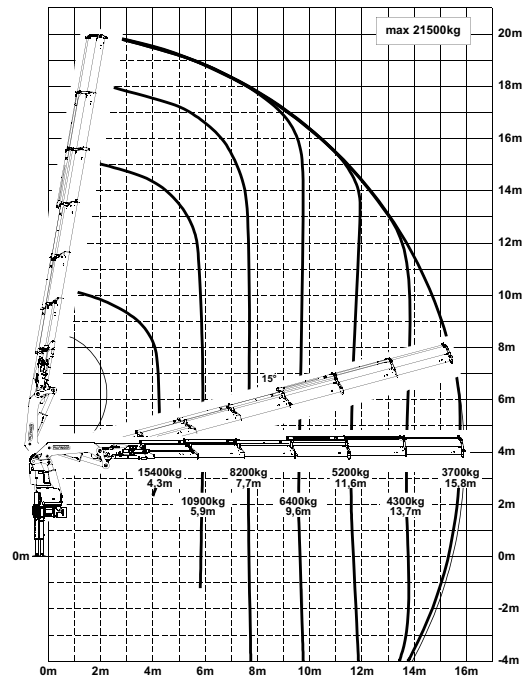

F

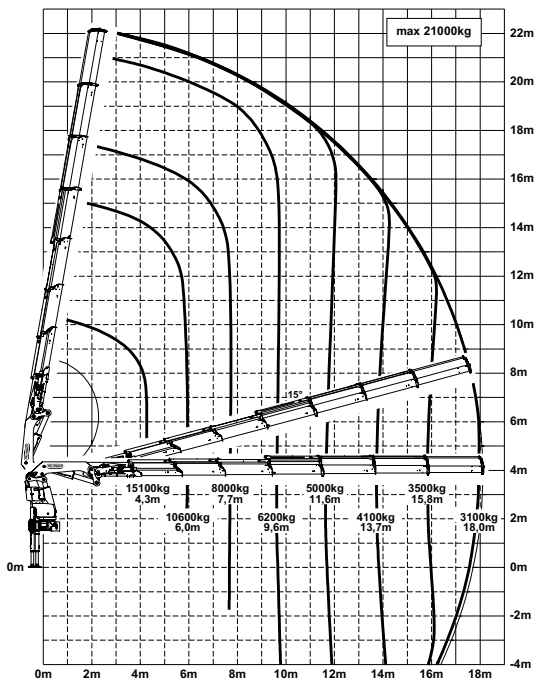

G

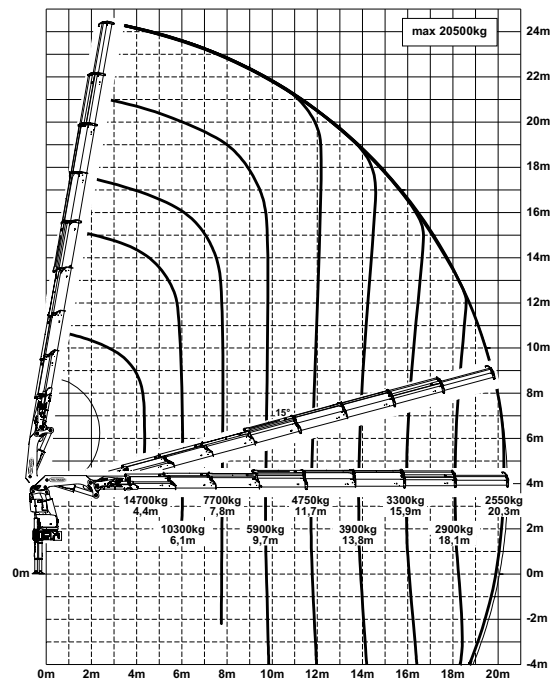

The outreaches stated are with a boom angle of 20° and are therefore not the maximum.

Lifting capacities

D PJ170E JV1

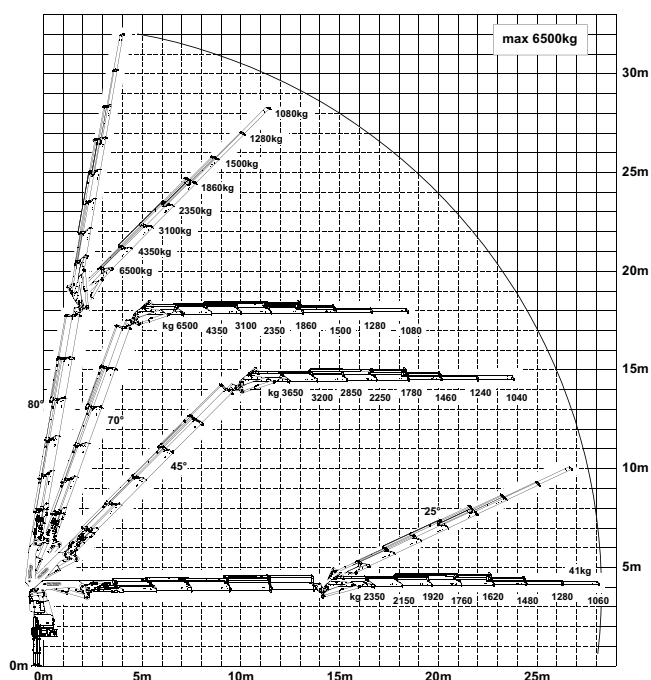

max.		23000 kg	50700 lbs	A
4.0 m	13 ft	17200 kg	37800 lbs	
5.7 m	19 ft	12300 kg	27200 lbs	
7.4 m	24 ft	9500 kg	21000 lbs	

max.		23000 kg	50700 lbs	B
4.1 m	13 ft	16800 kg	37000 lbs	
5.7 m	19 ft	12000 kg	26500 lbs	
7.5 m	24 ft	9200 kg	20300 lbs	
9.4 m	31 ft	7400 kg	16200 lbs	

max.		23000 kg	50700 lbs	C
4.1 m	13 ft	16600 kg	36500 lbs	
5.7 m	19 ft	11700 kg	25900 lbs	
7.5 m	24 ft	8900 kg	19700 lbs	
9.4 m	31 ft	7100 kg	15600 lbs	
11.4 m	37 ft	5800 kg	12800 lbs	

max.		22000 kg	48500 lbs	D
4.2 m	14 ft	15900 kg	35000 lbs	
5.8 m	19 ft	11300 kg	24800 lbs	
7.6 m	25 ft	8500 kg	18700 lbs	
9.5 m	31 ft	6700 kg	14700 lbs	
11.5 m	38 ft	5500 kg	12000 lbs	
13.6 m	45 ft	4600 kg	10100 lbs	

max.		21500 kg	47400 lbs	E
4.3 m	14 ft	15400 kg	33900 lbs	
5.9 m	19 ft	10900 kg	23900 lbs	
7.7 m	25 ft	8200 kg	18000 lbs	
9.6 m	31 ft	6400 kg	14100 lbs	
11.6 m	38 ft	5200 kg	11400 lbs	
13.7 m	45 ft	4300 kg	9500 lbs	
15.8 m	52 ft	3700 kg	8200 lbs	

E PJ125E JV1

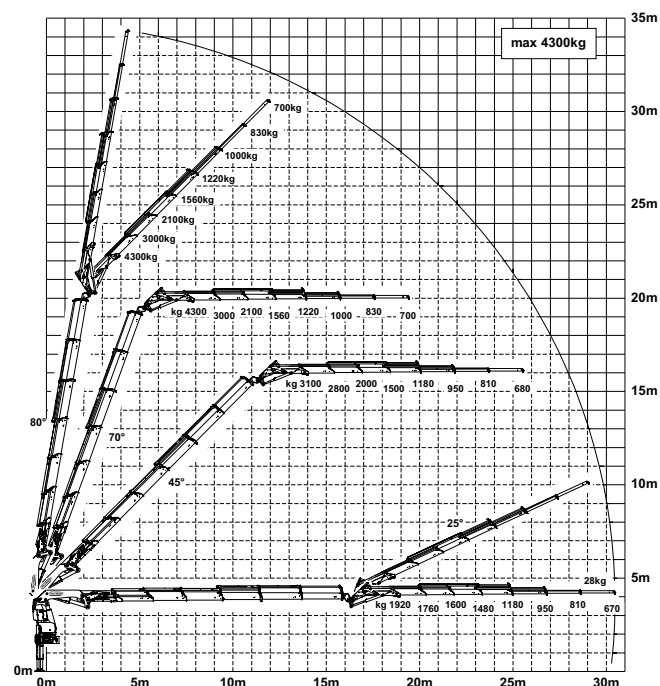

max.		21000 kg	46300 lbs	F
4.3 m	14 ft	15100 kg	33300 lbs	
6.0 m	20 ft	10600 kg	23400 lbs	
7.7 m	25 ft	8000 kg	17500 lbs	
9.6 m	32 ft	6200 kg	13600 lbs	
11.6 m	38 ft	5000 kg	10900 lbs	
13.7 m	45 ft	4100 kg	9000 lbs	
15.8 m	52 ft	3500 kg	7700 lbs	
18.0 m	59 ft	3100 kg	6800 lbs	

max.		20500 kg	45200 lbs	G
4.4 m	14 ft	14700 kg	32300 lbs	
6.1 m	20 ft	10300 kg	22700 lbs	
7.8 m	26 ft	7700 kg	16900 lbs	
9.7 m	32 ft	5900 kg	13100 lbs	
11.7 m	38 ft	4750 kg	10400 lbs	
13.8 m	45 ft	3900 kg	8600 lbs	
15.9 m	52 ft	3300 kg	7300 lbs	
18.1 m	59 ft	2900 kg	6300 lbs	
20.3 m	66 ft	2550 kg	5600 lbs	
22.6 m*	74 ft	1900 kg	4200 lbs	
24.9 m*	82 ft	1200 kg	2650 lbs	

*mechanical extension



KP-PK76002EHM2+EN

Cranes shown in the leaflet are partially optional equipped and do not always correspond to the standard version. Country-specific regulations must be observed. Dimensions may vary. Subject to technical changes, errors and translation mistakes.